

# Krazy Darts Powered By **LASERTRON**

## SPACE REQUIREMENTS AND OVERALL DIMENSIONS

(2) FULL HEIGHT LANES WITH FURNITURE SIDE BY SIDE

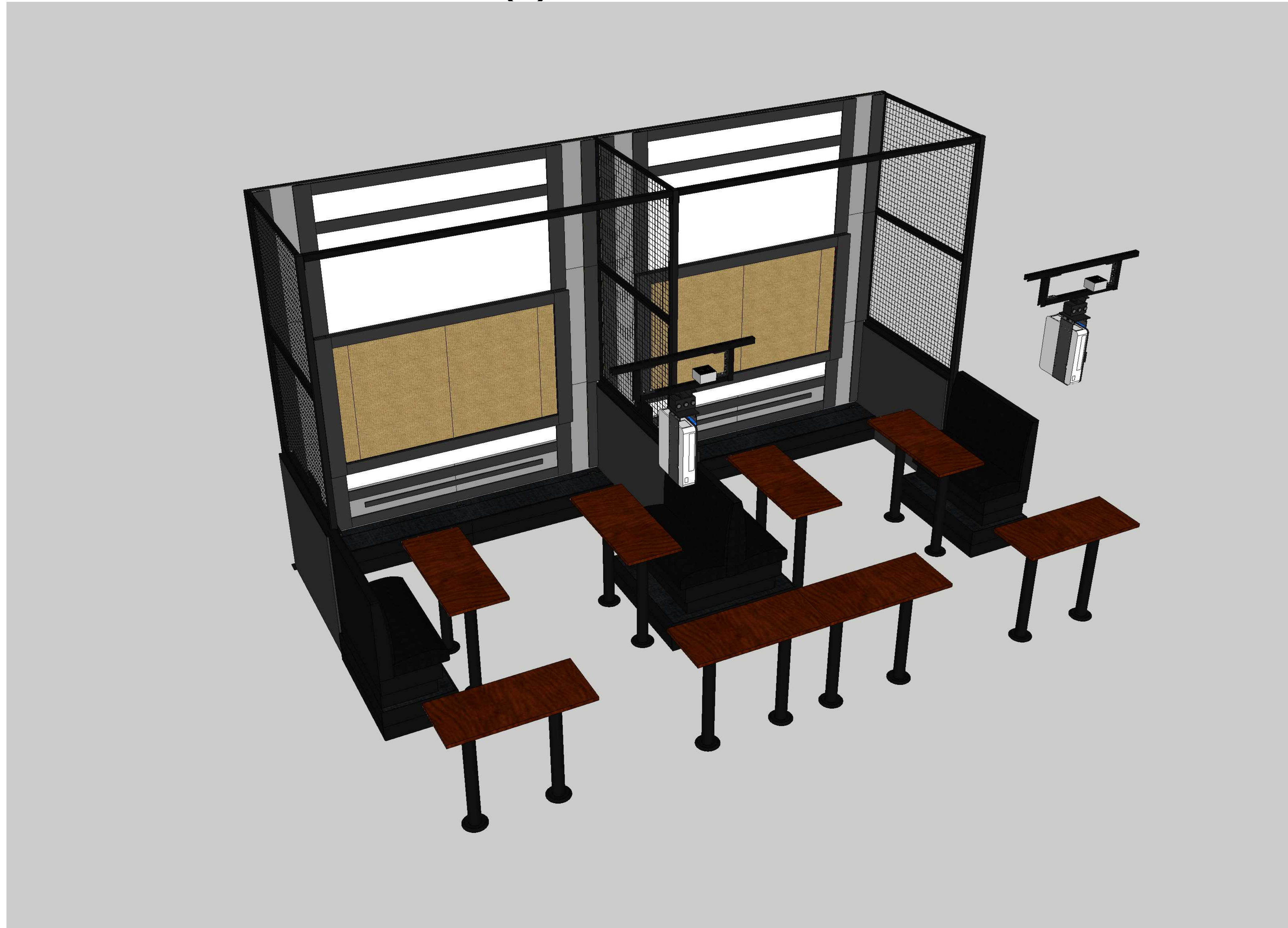

### TABLE OF CONTENTS

TITLE PAGE .....	PAGE 1
REQUIRED SPACE .....	PAGE 2
PLAN VIEW .....	PAGE 3
ELEVATIONS .....	PAGE 4-5
OVERALL VIEW .....	PAGE 6

### PAINT SWATCH KEY

 PNT-1: COLOR: 4011-2 "DARK KETTLE BLACK" VALSPAR FINISH: SATIN	 PNT-2: COLOR: 4005-2B "HIGH-SPEED STEEL" VALSPAR FINISH: SATIN
---	---

THIS DOCUMENT BEST VIEWED WHEN PRINTED AT 36" X 24".

### REVISION HISTORY

INITIALS	DATE	REVISION DESCRIPTION
MB	07-19-2023	INITIAL DRAWING

THIS DOCUMENT IS THE PROPERTY OF LASERTRON, INC. AND HAS BEEN PREPARED AND ISSUED FOR A SPECIFIC PROJECT AS MARKED ON THIS DOCUMENT. THE RECIPIENT BY ACCEPTING THIS DOCUMENT ASSUMES CUSTODY AND AGREES THAT THIS DOCUMENT WILL NOT BE COPIED OR REPRODUCED IN PART OR IN WHOLE. ALL SPECIAL FEATURES OF THIS DESIGN SHALL NOT BE INCORPORATED IN ANY OTHER PROJECT, UNLESS THE PRIOR WRITTEN AGREEMENT OF LASERTRON HAS BEEN OBTAINED. THIS DOCUMENT WILL BE RETURNED UPON THE COMPLETION OF THE PROJECT CONTEMPLATED BY THE DOCUMENTS OR UPON THE REQUEST OF LASERTRON. THIS DOCUMENT IS THE EXCLUSIVE PROPERTY OF LASERTRON, NO RIGHTS TO OWNERSHIP ARE TRANSFERABLE, OR SHALL BE LOST BY THE FILING OF THIS DOCUMENT WITH ANY AND ALL PUBLIC AUTHORITIES FOR ANY PURPOSES.



**IMPORTANT NOTES:**

SUFFICIENT SPACE FOR ATTRACTION IS REQUIRED PRIOR TO INSTALLATION. REQUIRED SPACE MUST BE CLEAR OF ALL GROUND, WALL, AND CEILING OBSTRUCTIONS.

OBSTRUCTIONS INCLUDE BUT ARE NOT LIMITED TO:

- HEATING AND PLUMBING PIPES
- STRUCTURAL BEAMS, COLUMNS, JOISTS, GIRDERS, POSTS, AND OTHER STRUCTURES.
- NON-SUGGESTED LIGHTING
- OTHER ATTRACTIONS
- ANYTHING THAT MAY OBSTRUCT THE CONSTRUCTION OR COMPLETION OF THE AXE THROWING ATTRACTION

REQUIRED SPACE IS BASED ON THE SIZE OF THE ATTRACTION AND ALL OF ITS COMPONENTS. IF THE REQUIRED SPACE IS TOO LARGE FOR YOUR PARTICULAR LOCATION, PLEASE CONTACT YOUR LASERTRON REPRESENTATIVE TO DISCUSS FURTHER OPTIONS.

**OVERALL DIMENTIONS:**

A HEIGHT OF 12'-3" IS REQUIRED

A LENGTH OF 17' IS REQUIRED

A WIDTH OF 21'-0" IS REQUIRED

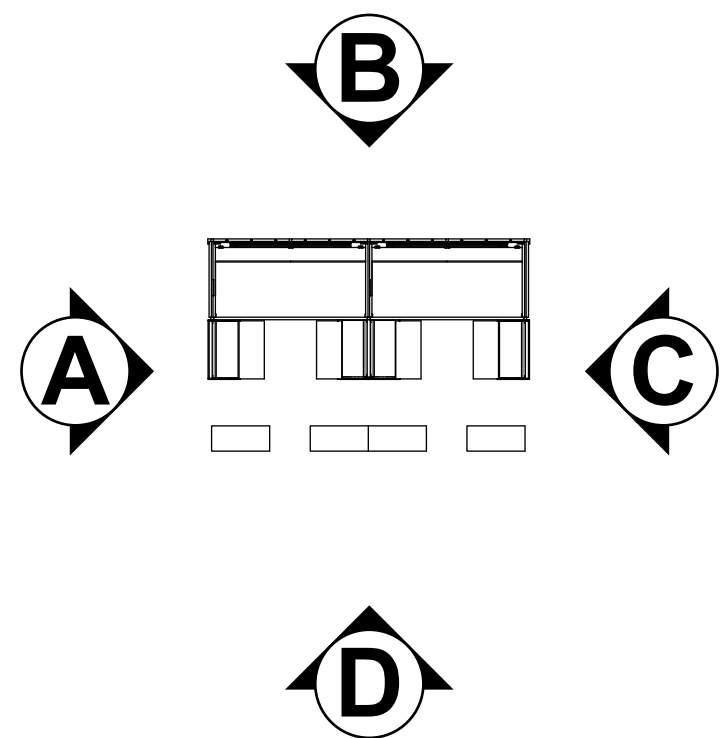
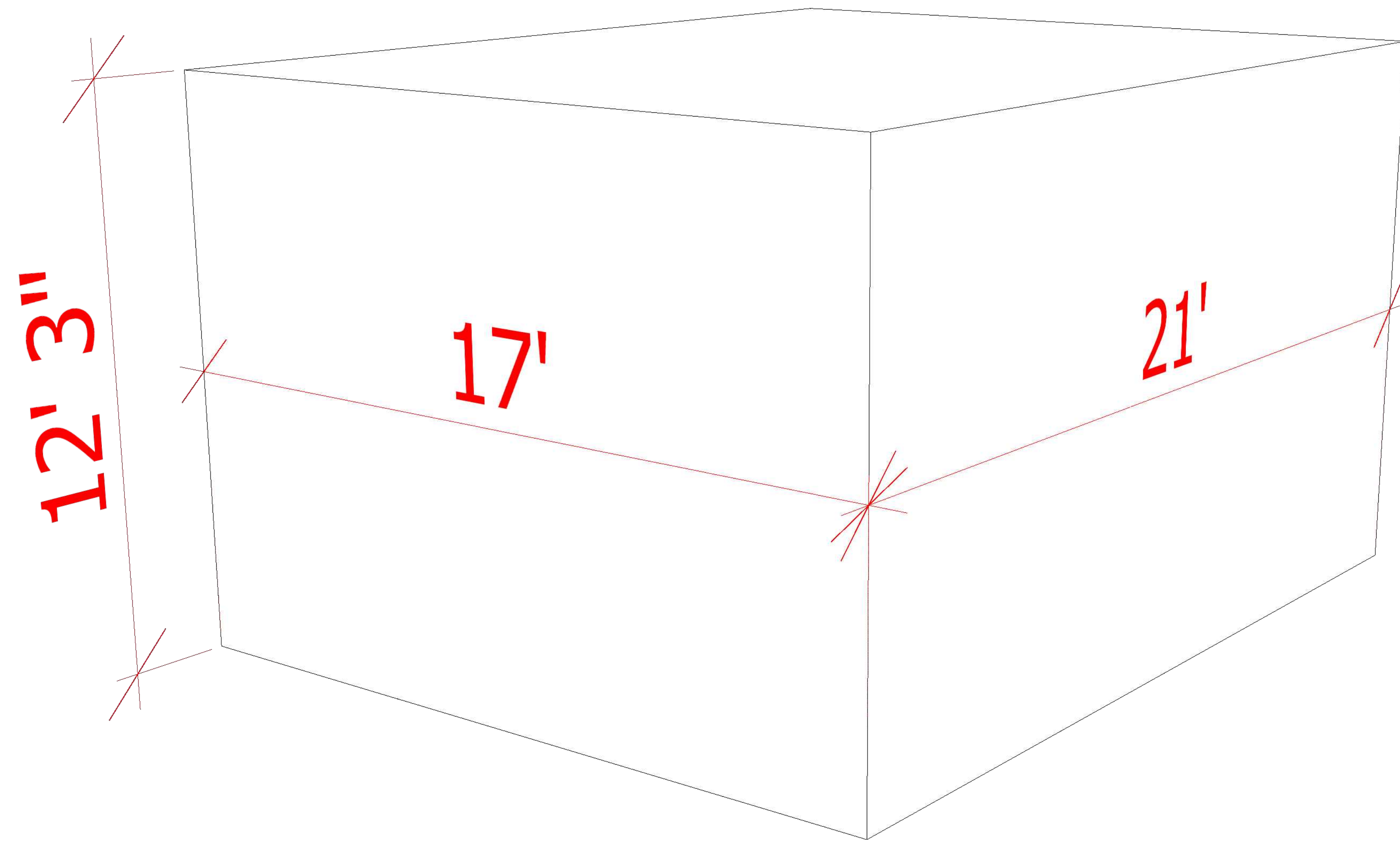

THIS DOCUMENT BEST VIEWED  
WHEN PRINTED AT 36" X 24".

# REQUIRED SPACE

THIS DOCUMENT IS THE PROPERTY OF LASERTRON, INC. AND HAS BEEN PREPARED AND ISSUED FOR A SPECIFIC PROJECT AS MARKED ON THIS DOCUMENT. THE RECIPIENT BY ACCEPTING THIS DOCUMENT ASSUMES CUSTODY AND AGREES THAT THIS DOCUMENT WILL NOT BE COPIED OR REPRODUCED IN PART OR IN WHOLE. ALL SPECIAL FEATURES OF THIS DESIGN SHALL NOT BE INCORPORATED IN ANY OTHER PROJECT, UNLESS THE PRIOR WRITTEN AGREEMENT OF LASERTRON HAS BEEN OBTAINED. THIS DOCUMENT WILL BE RETURNED UPON THE COMPLETION OF THE PROJECT CONTEMPLATED BY THE DOCUMENTS OR UPON THE REQUEST OF LASERTRON. THIS DOCUMENT IS THE EXCLUSIVE PROPERTY OF LASERTRON, NO RIGHTS TO OWNERSHIP ARE TRANSFERABLE, OR SHALL BE LOST BY THE FILING OF THIS DOCUMENT WITH ANY AND ALL PUBLIC AUTHORITIES FOR ANY PURPOSES.

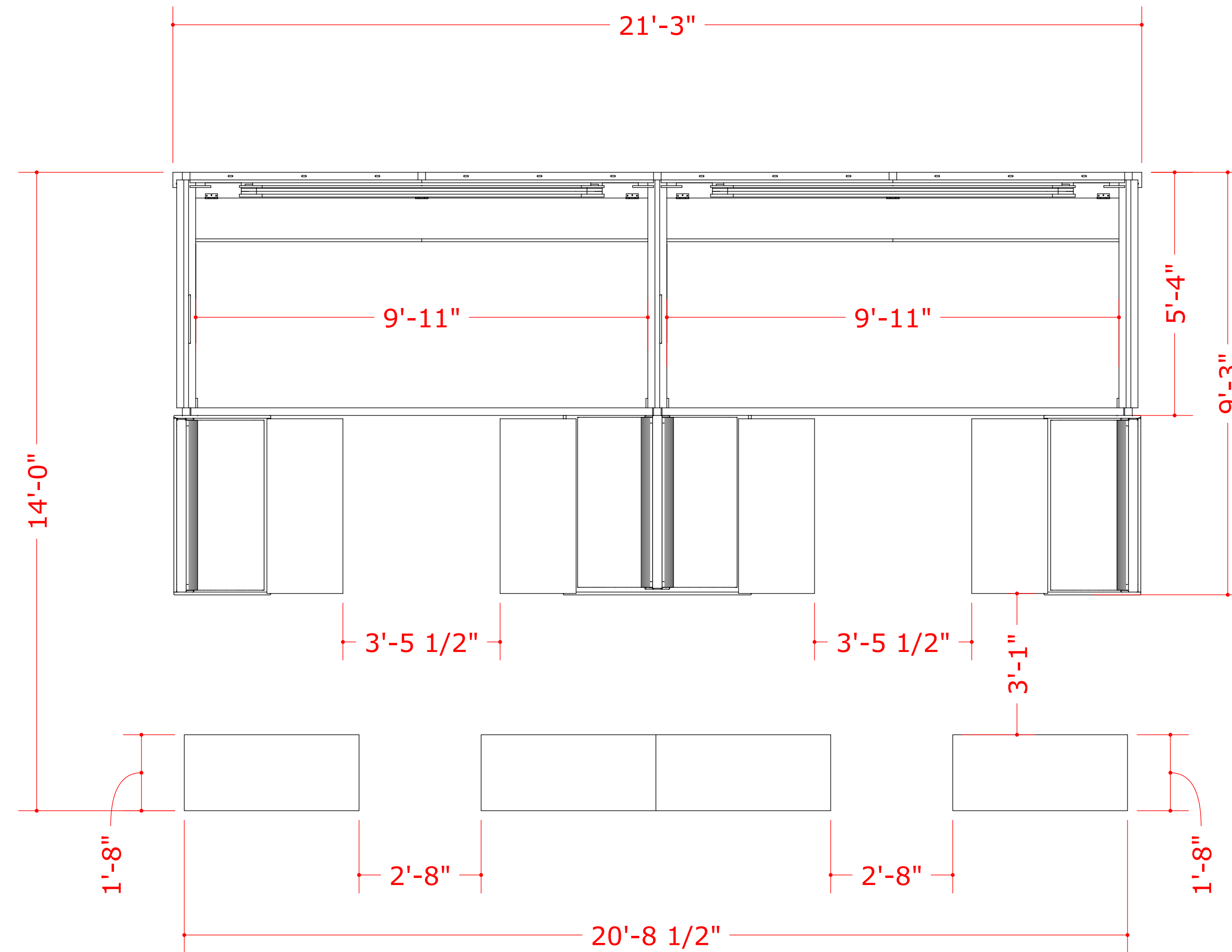

**PLAN VIEW**

SCALE 1/2"=1'-0"

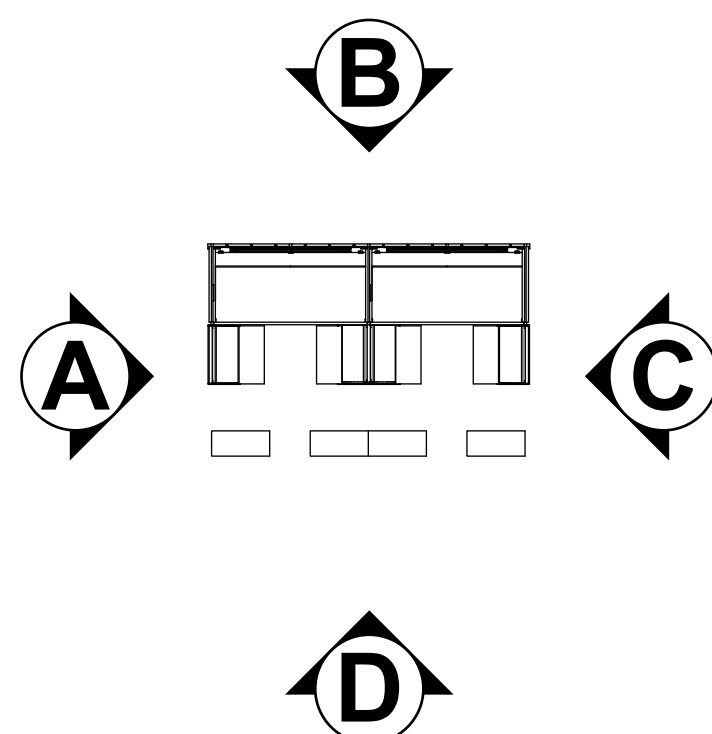

THIS DOCUMENT BEST VIEWED  
WHEN PRINTED AT 36" X 24".

**OVERALL DIMENSIONS**

THIS DOCUMENT IS THE PROPERTY OF LASERTRON, INC. AND HAS BEEN PREPARED AND ISSUED FOR A SPECIFIC PROJECT AS MARKED ON THIS DOCUMENT. THE RECIPIENT BY ACCEPTING THIS DOCUMENT ASSUMES CUSTODY AND AGREES THAT THIS DOCUMENT WILL NOT BE COPIED OR REPRODUCED IN PART OR IN WHOLE. ALL SPECIAL FEATURES OF THIS DESIGN SHALL NOT BE INCORPORATED IN ANY OTHER PROJECT, UNLESS THE PRIOR WRITTEN AGREEMENT OF LASERTRON HAS BEEN OBTAINED. THIS DOCUMENT WILL BE RETURNED UPON THE COMPLETION OF THE PROJECT CONTEMPLATED BY THE DOCUMENTS OR UPON THE REQUEST OF LASERTRON. THIS DOCUMENT IS THE EXCLUSIVE PROPERTY OF LASERTRON, NO RIGHTS TO OWNERSHIP ARE TRANSFERABLE, OR SHALL BE LOST BY THE FILING OF THIS DOCUMENT WITH ANY AND ALL PUBLIC AUTHORITIES FOR ANY PURPOSES.

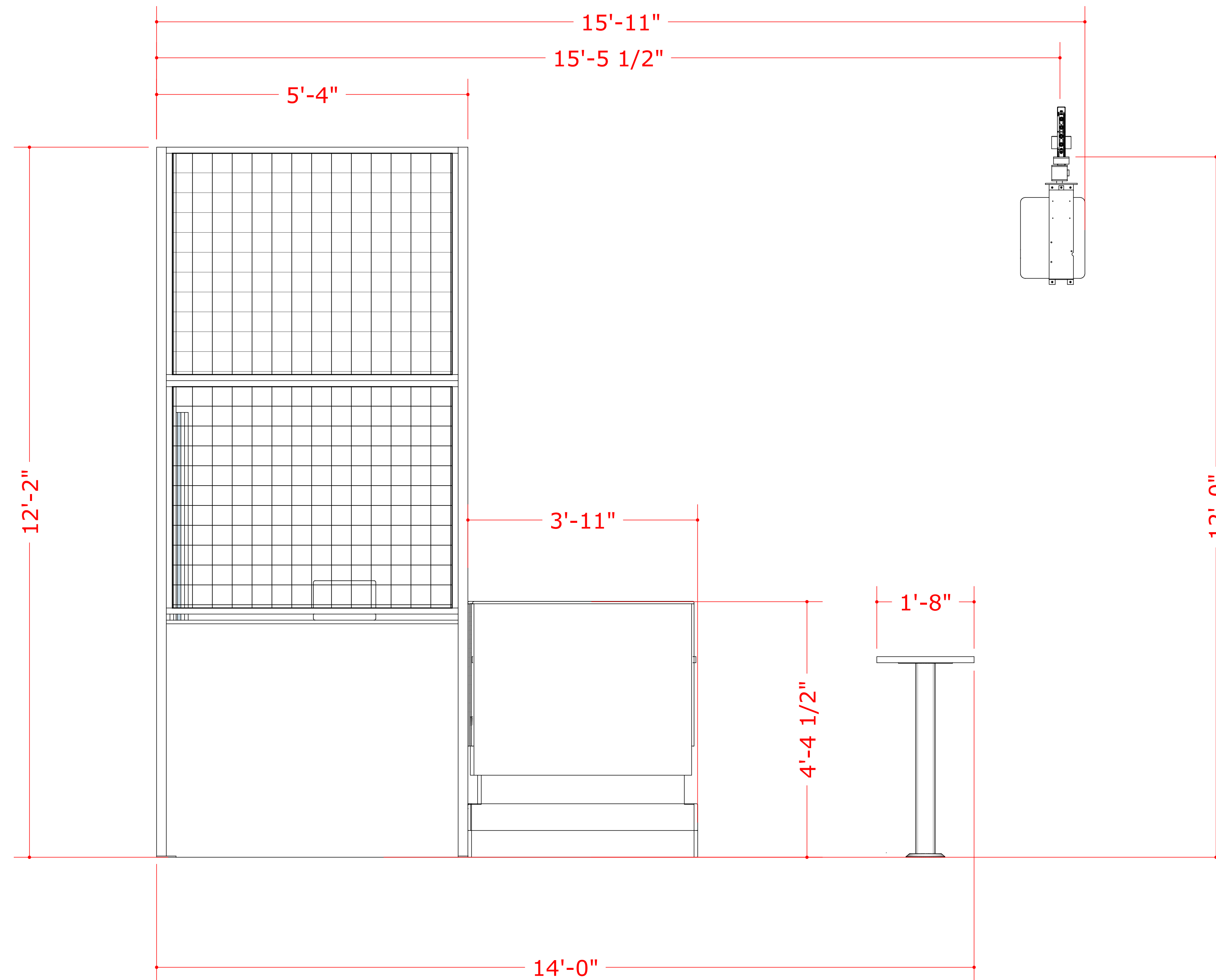

### ELEVATION A

SCALE 3/4"=1'-0"

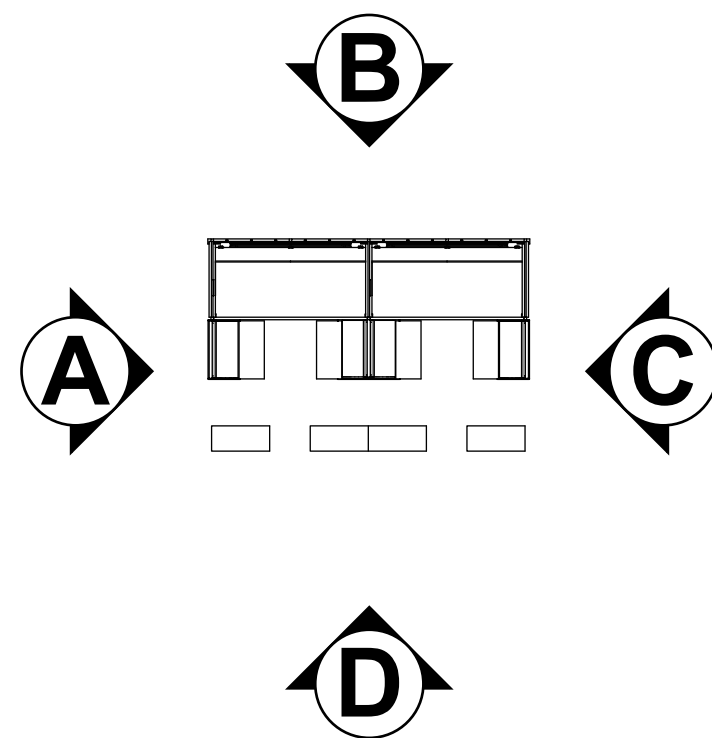

THIS DOCUMENT BEST VIEWED  
WHEN PRINTED AT 36" X 24".

# OVERALL DIMENSIONS

THIS DOCUMENT IS THE PROPERTY OF LASERTRON, INC. AND HAS BEEN PREPARED AND ISSUED FOR A SPECIFIC PROJECT AS MARKED ON THIS DOCUMENT. THE RECIPIENT BY ACCEPTING THIS DOCUMENT ASSUMES CUSTODY AND AGREES THAT THIS DOCUMENT WILL NOT BE COPIED OR REPRODUCED IN PART OR IN WHOLE. ALL SPECIAL FEATURES OF THIS DESIGN SHALL NOT BE INCORPORATED IN ANY OTHER PROJECT, UNLESS THE PRIOR WRITTEN AGREEMENT OF LASERTRON HAS BEEN OBTAINED. THIS DOCUMENT WILL BE RETURNED UPON THE COMPLETION OF THE PROJECT CONTEMPLATED BY THE DOCUMENTS OR UPON THE REQUEST OF LASERTRON. THIS DOCUMENT IS THE EXCLUSIVE PROPERTY OF LASERTRON, NO RIGHTS TO OWNERSHIP ARE TRANSFERABLE, OR SHALL BE LOST BY THE FILING OF THIS DOCUMENT WITH ANY AND ALL PUBLIC AUTHORITIES FOR ANY PURPOSES.

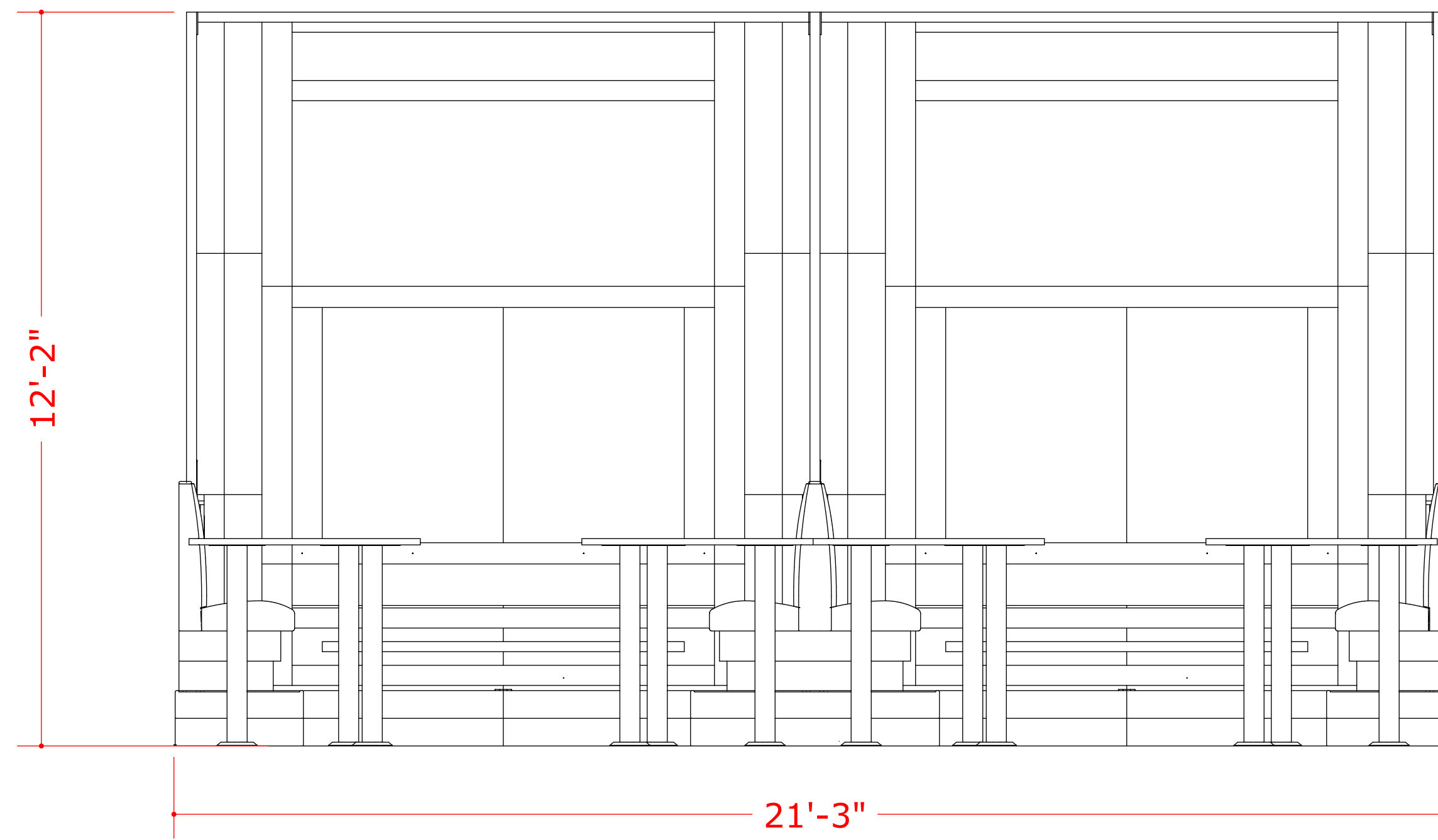

**ELEVATION D**  
SCALE 1/2"=1'-0"

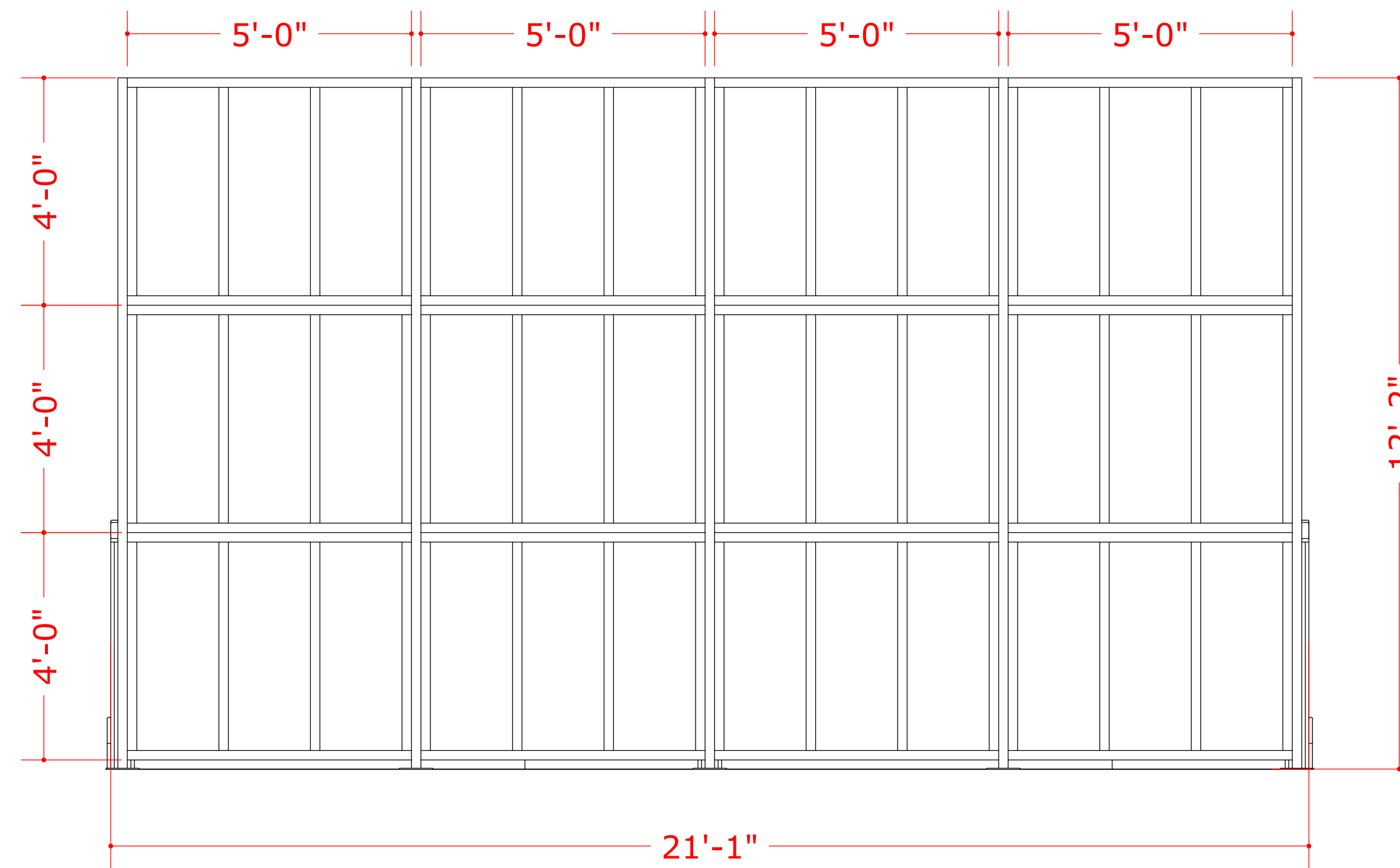

**ELEVATION B**  
SCALE 1/2"=1'-0"

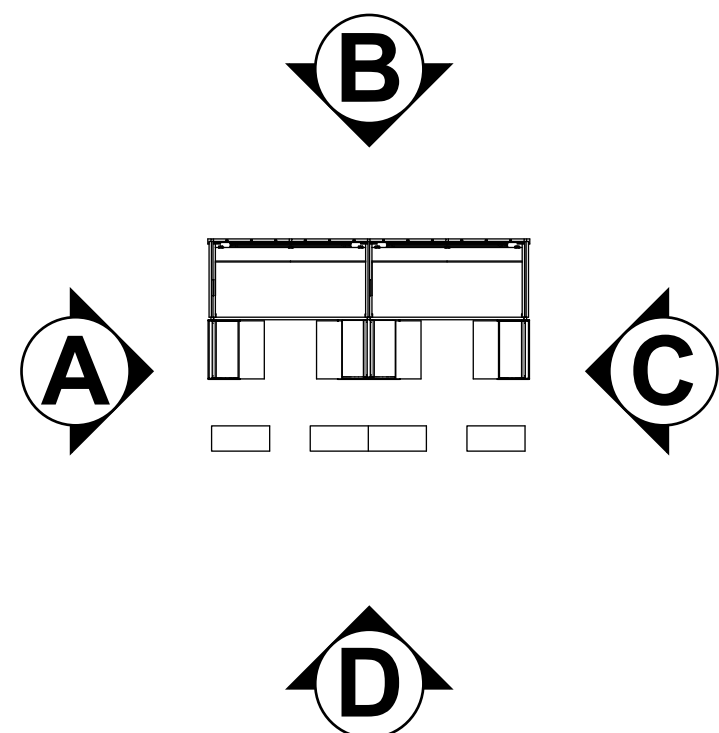

THIS DOCUMENT BEST VIEWED  
WHEN PRINTED AT 36" X 24".

# OVERALL DIMENSIONS

THIS DOCUMENT IS THE PROPERTY OF LASERTRON, INC. AND HAS BEEN PREPARED AND ISSUED FOR A SPECIFIC PROJECT AS MARKED ON THIS DOCUMENT. THE RECIPIENT BY ACCEPTING THIS DOCUMENT ASSUMES CUSTODY AND AGREES THAT THIS DOCUMENT WILL NOT BE COPIED OR REPRODUCED IN PART OR IN WHOLE. ALL SPECIAL FEATURES OF THIS DESIGN SHALL NOT BE INCORPORATED IN ANY OTHER PROJECT, UNLESS THE PRIOR WRITTEN AGREEMENT OF LASERTRON HAS BEEN OBTAINED. THIS DOCUMENT WILL BE RETURNED UPON THE COMPLETION OF THE PROJECT CONTEMPLATED BY THE DOCUMENTS OR UPON THE REQUEST OF LASERTRON. THIS DOCUMENT IS THE EXCLUSIVE PROPERTY OF LASERTRON, NO RIGHTS TO OWNERSHIP ARE TRANSFERABLE, OR SHALL BE LOST BY THE FILING OF THIS DOCUMENT WITH ANY AND ALL PUBLIC AUTHORITIES FOR ANY PURPOSES.



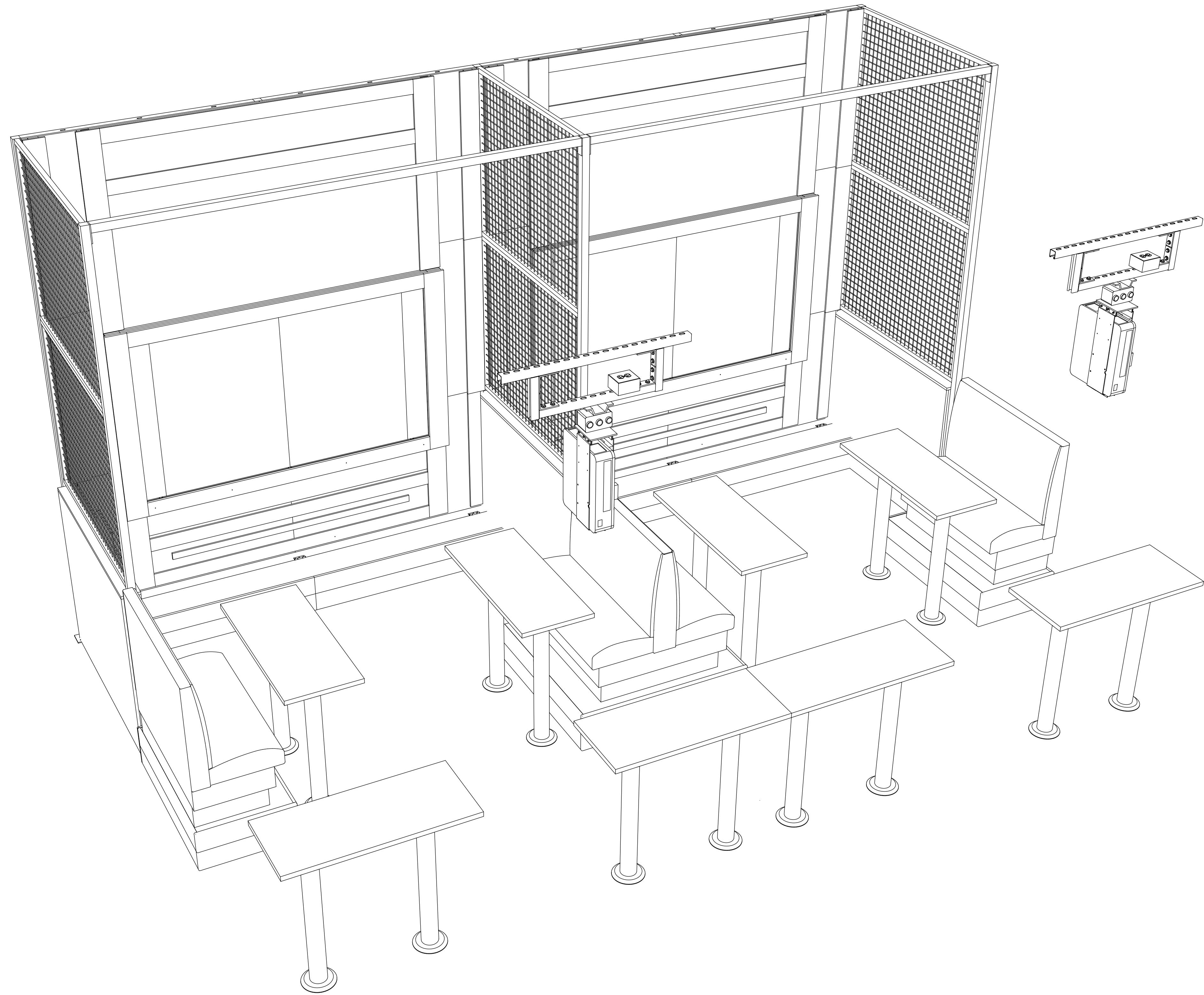

# OVERALL VIEW

THIS DOCUMENT IS THE PROPERTY OF LASERTRON, INC. AND HAS BEEN PREPARED AND ISSUED FOR A SPECIFIC PROJECT AS MARKED ON THIS DOCUMENT. THE RECIPIENT BY ACCEPTING THIS DOCUMENT ASSUMES CUSTODY AND AGREES THAT THIS DOCUMENT WILL NOT BE COPIED OR REPRODUCED IN PART OR IN WHOLE. ALL SPECIAL FEATURES OF THIS DESIGN SHALL NOT BE INCORPORATED IN ANY OTHER PROJECT, UNLESS THE PRIOR WRITTEN AGREEMENT OF LASERTRON HAS BEEN OBTAINED. THIS DOCUMENT WILL BE RETURNED UPON THE COMPLETION OF THE PROJECT CONTEMPLATED BY THE DOCUMENTS OR UPON THE REQUEST OF LASERTRON. THIS DOCUMENT IS THE EXCLUSIVE PROPERTY OF LASERTRON, NO RIGHTS TO OWNERSHIP ARE TRANSFERABLE, OR SHALL BE LOST BY THE FILING OF THIS DOCUMENT WITH ANY AND ALL PUBLIC AUTHORITIES FOR ANY PURPOSES.